



AH31

High Dynamic Range IF Amplifier

Product Features

- 50 – 1000 MHz
- 19 dB Gain
- +22 dBm P1dB
- +42 dBm OIP3
- 1.9 dB Noise Figure
- Single Voltage Supply (+5 V)
- Lead-free/Green/RoHS-compliant SOT-89 Package
- MTTF > 1000 years

Applications

- High linearity and low-noise amplifier following a mixer
- High performance amplifier in IF path of TX/RX systems

Product Description

The AH31 is a high dynamic range amplifier in a low-cost surface-mount package. The combination of low noise figure, high gain, and high output IP3 is ideal as an IF amplifier for receiver and transmitter applications.

The device combines dependable performance with consistent quality to maintain MTTF values exceeding 1000 years at mounting temperatures of +85 °C and is available in the environmentally-friendly lead-free/green/RoHS-compliant SOT-89 package. All devices are 100% RF & DC tested.

The MMIC amplifier based on GaAs MESFET technology can be configured for IF and RF applications with various current and next generation wireless technologies.

Functional Diagram

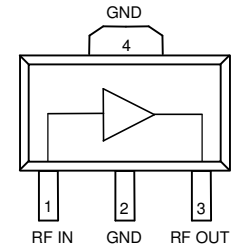

| Function | Pin No. |
|-------------|---------|
| Input | 1 |
| Output/Bias | 3 |
| Ground | 2, 4 |

Specifications ⁽¹⁾

| Parameter | Units | Min | Typ | Max |
|---------------------------|-------|-----|-----|------|
| Operational Bandwidth | MHz | 50 | | 1000 |
| Test Frequency | MHz | | 240 | |
| Gain ⁽³⁾ | dB | | 19 | |
| Output P1dB | dBm | | +22 | |
| Output IP3 ⁽²⁾ | dBm | +37 | +42 | |
| Supply Voltage | V | | +5 | |
| Operating Current Range | mA | 120 | 150 | 180 |

1. Test conditions : T = 25°C, Vdd = +5 V, 50 Ω system.
 2. 3OIP measured with two tones at an output power of +5 dBm/tone separated by 1 MHz. The suppression on the largest IM3 product is used to calculate the 3OIP using a 2:1 rule.

Typical Performance ⁽³⁾

| Parameter | Units | Typical | | | | |
|--------------|-------|---------|------|------|------|------|
| Frequency | MHz | 75 | 170 | 240 | 500 | 900 |
| S21 | dB | 19.5 | 19.2 | 19.3 | 18.4 | 16.6 |
| S11 | dB | -21 | -13 | -19 | -13 | -14 |
| S22 | dB | -17 | -14 | -13 | -9.2 | -9 |
| Output P1dB | dBm | +22 | +21 | +22 | +21 | +20 |
| Output IP3 | dBm | +42 | +42 | +42 | +41 | +41 |
| Noise Figure | dB | 2.6 | 2.3 | 2.2 | 1.9 | 2.2 |

3. Typical parameters reflect performance in an application circuit.

Absolute Maximum Rating

| Parameter | Rating |
|-----------------------------|-----------------------|
| Operating Case Temperature | -40 to +85 °C |
| Storage Temperature | -55 to +150 °C |
| DC Voltage | +6 V |
| RF Input Power (continuous) | 4 dB above Input P1dB |
| Junction Temperature | +220 °C |

Operation of this device above any of these parameters may cause permanent damage.

Ordering Information

| Part No. | Description |
|-------------|---|
| AH31* | High Dynamic Range IF Amplifier (lead-tin SOT-89 Pkg) |
| AH31-G | High Dynamic Range IF Amplifier (lead-free/green/RoHS-compliant SOT-89 Pkg) |
| AH31-PCB75 | 65 – 85 MHz Fully Assembled Evaluation Board |
| AH31-PCB170 | 155 – 185 MHz Fully Assembled Evaluation Board |
| AH31-PCB240 | 220 – 260 MHz Fully Assembled Evaluation Board |
| AH31-PCB500 | 450 – 550 MHz Fully Assembled Evaluation Board |

* This package is being phased out in favor of the green package type which is backwards compatible for existing designs. Refer to Product Change Notification WJPCN06MAY05TC1 on the WJ website. Specifications and information are subject to change without notice.



Typical Device Data

S-parameters ($V_D = +5\text{ V}$, $I_D = 150\text{ mA}$, unmatched $50\ \Omega$ system).

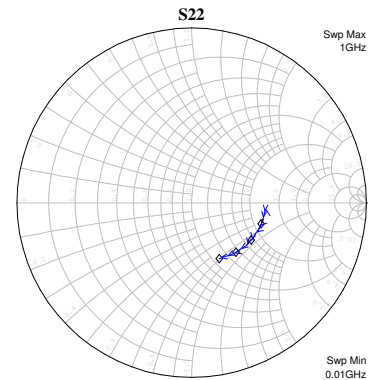
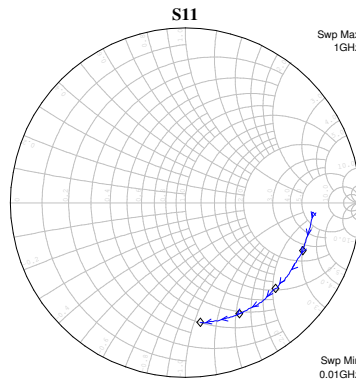
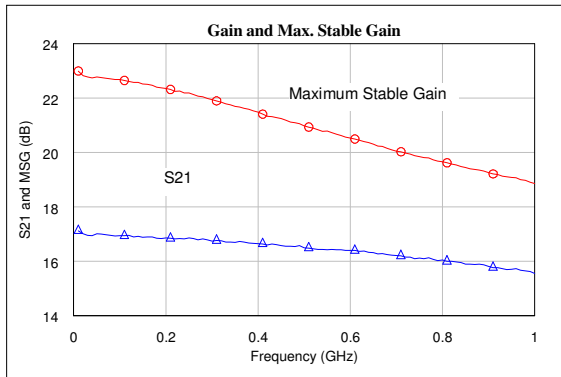

Notes:

- Measurements are shown for an unmatched packaged device with the data being de-embedded to the device leads.
- The amplifier requires a matching network at the input for proper operation. The amplifier is intrinsically well matched at the output and ideally should “look” into $50\ \Omega$. Any deviation from this can affect the linearity IP3 performance for the device.
- For a tuned circuit for a particular frequency, it is expected that actual gain will be higher, up to the maximum stable gain. The maximum stable gain is shown in the dashed red line.
- The impedance plots are shown from 250 – 1000 MHz, with markers placed at 0.25 – 1.0 GHz in 0.25 GHz increments.

Application Circuit PC Board Layout

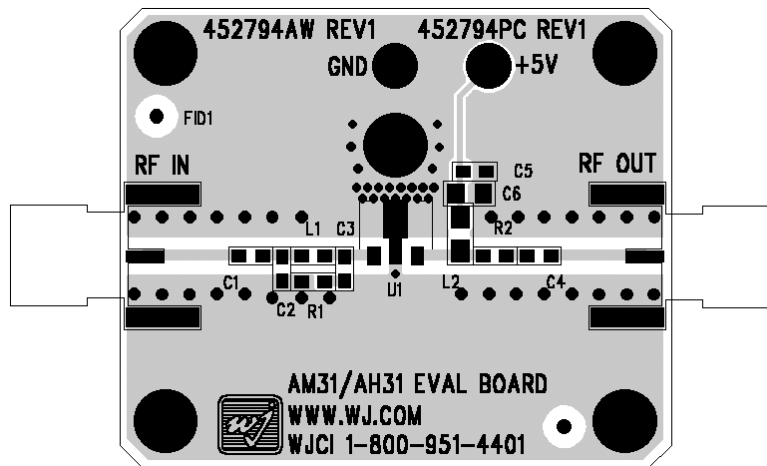

Circuit Board Material: .014" FR-4, 4 layers (other layers added for rigidity), .062" total thickness, 1 oz copper
Microstrip line details: width = .024", spacing = .036"

Typical Device Data

S-Parameters ($V_D = +5\text{ V}$, $I_D = 150\text{ mA}$, $T = 25^\circ\text{C}$, calibrated to device leads)

| Freq (MHz) | S11 (dB) | S11 (ang) | S21 (dB) | S21 (ang) | S12 (dB) | S12 (ang) | S22 (dB) | S22 (ang) |
|------------|----------|-----------|----------|-----------|----------|-----------|----------|-----------|
| 50 | -2.72 | -5.46 | 17.01 | 175.91 | -28.54 | 6.89 | -7.44 | -5.46 |
| 100 | -2.77 | -9.52 | 16.94 | 172.89 | -28.42 | 8.53 | -7.56 | -7.93 |
| 200 | -2.81 | -18.01 | 16.86 | 166.99 | -27.86 | 14.09 | -7.59 | -13.42 |
| 300 | -2.87 | -26.32 | 16.74 | 161.33 | -27.14 | 18.38 | -7.63 | -19.94 |
| 400 | -2.87 | -35.19 | 16.64 | 155.16 | -26.32 | 21.01 | -7.83 | -26.57 |
| 500 | -2.95 | -43.58 | 16.50 | 149.45 | -25.45 | 22.42 | -7.92 | -32.04 |
| 600 | -2.91 | -51.71 | 16.40 | 143.72 | -24.66 | 22.73 | -8.00 | -38.12 |
| 700 | -2.99 | -60.03 | 16.21 | 138.07 | -23.89 | 21.29 | -8.31 | -45.01 |
| 800 | -3.03 | -67.73 | 16.05 | 132.16 | -23.27 | 19.94 | -8.46 | -50.89 |
| 900 | -3.14 | -75.45 | 15.81 | 126.99 | -22.71 | 17.74 | -8.77 | -57.30 |
| 1000 | -3.22 | -82.88 | 15.55 | 121.64 | -22.17 | 15.73 | -8.95 | -63.63 |



Application Circuit: 65 – 85 MHz (AH31-PCB75)

Typical Performance

| Frequency | 75 MHz |
|--------------|---------------|
| Gain | 19.5 dB |
| S11 | -21 dB |
| S22 | -17 dB |
| Output P1dB | +22 dBm |
| Output IP3 | +42 dBm |
| Noise Figure | 2.6 dB |
| Bias | +5 V @ 150 mA |

Notes:

1. The amplifier should be connected directly to a +5 V regulator; no dropping resistor is required.
2. If no DC signal is present at the input (pin 1), C1 can be removed. The gate is internally grounded in the amplifier.
3. R2 is used as a placeholder for a different application circuit. It can be removed from the circuit.
4. C2 (from the silkscreen) is not utilized in this application circuit.

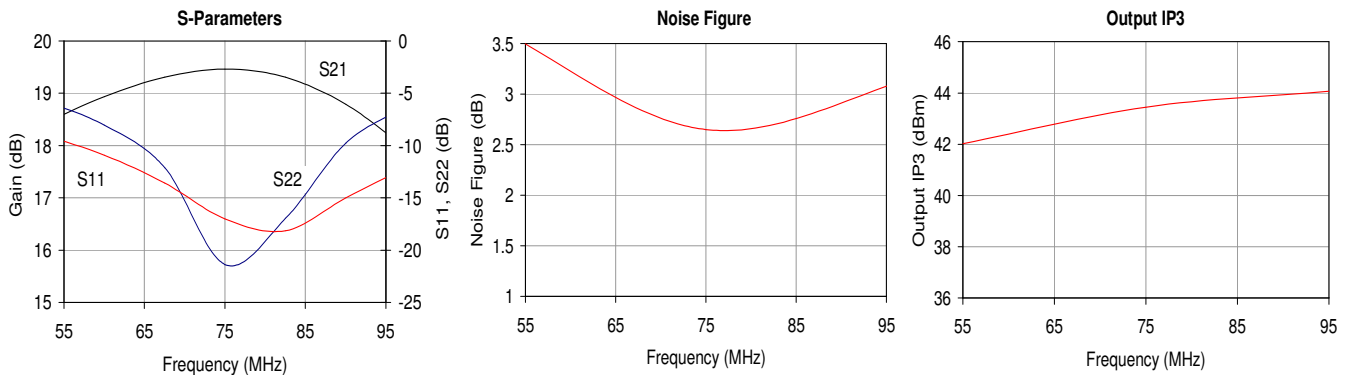
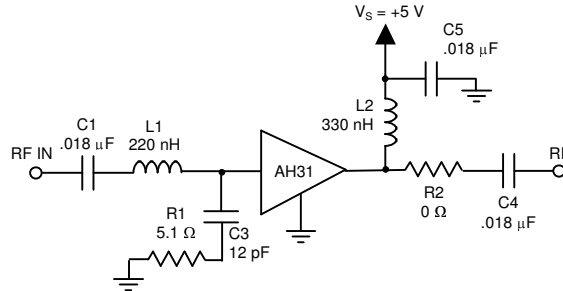

Application Circuit: 155 – 185 MHz (AH31-PCB170)

Typical Performance

| Frequency | 170 MHz |
|--------------|---------------|
| Gain | 19.2 dB |
| S11 | -13 dB |
| S22 | -14 dB |
| Output P1dB | +21 dBm |
| Output IP3 | +42 dBm |
| Noise Figure | 2.3 dB |
| Bias | +5 V @ 150 mA |

Notes:

1. The amplifier should be connected directly to a +5 V regulator; no dropping resistor is required.
2. If no DC signal is present at the input (pin 1), C1 can be removed. The gate is internally grounded in the amplifier.
3. R2 is used as a placeholder for a different application circuit. It can be removed from the circuit.
4. C2 (from the silkscreen) is not utilized in this application circuit.

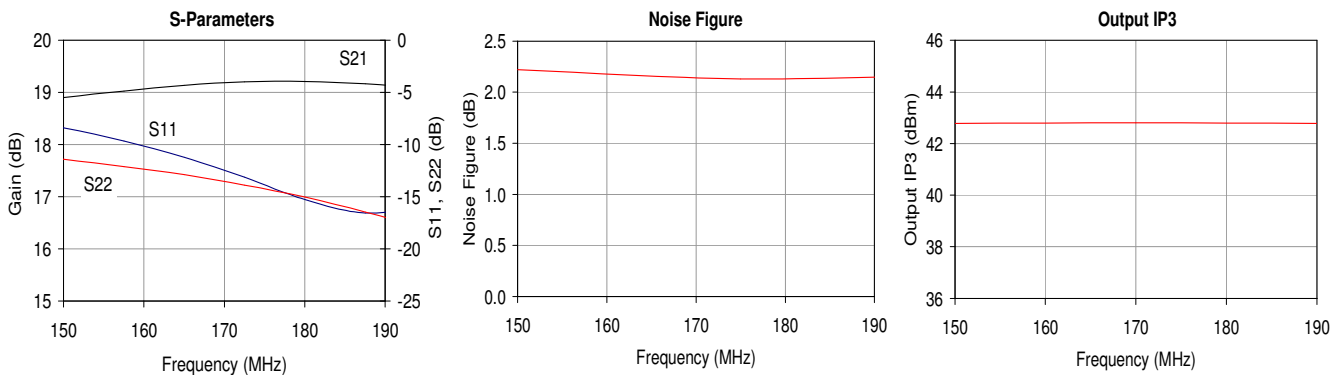
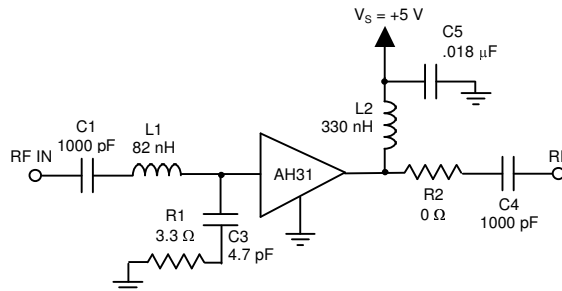



Application Circuit: 220 – 260 MHz (AH31-PCB240)

Typical Performance

| Frequency | 240 MHz |
|--------------|---------------|
| Gain | 19.3 dB |
| S11 | -19 dB |
| S22 | -12.5 dB |
| Output P1dB | +22 dBm |
| Output IP3 | +42 dBm |
| Noise Figure | 2.2 dB |
| Bias | +5 V @ 150 mA |

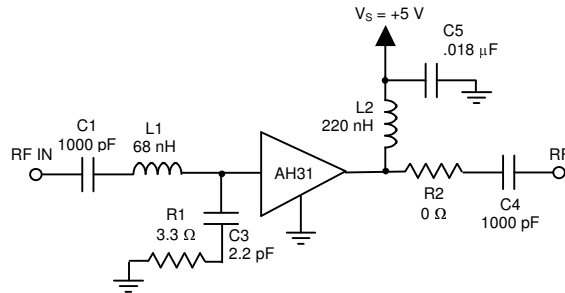

Notes:

1. The amplifier should be connected directly to a +5 V regulator; no dropping resistor is required.
2. If no DC signal is present at the input (pin 1), C1 can be removed. The gate is internally grounded in the amplifier.
3. R2 is used as a placeholder for a different application circuit. It can be removed from the circuit.
4. C2 (from the silkscreen) is not utilized in this application circuit.

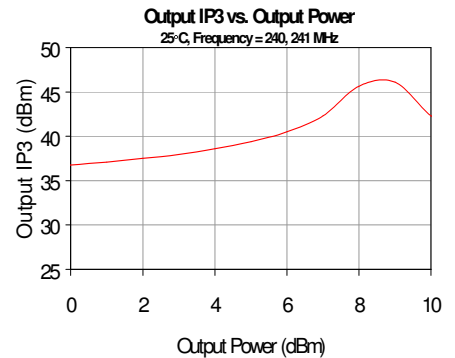
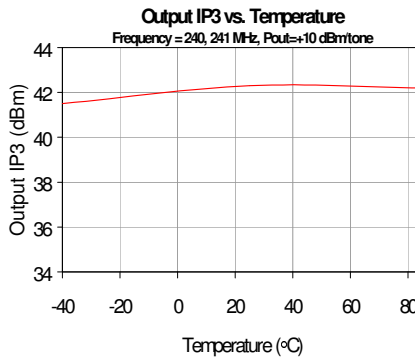
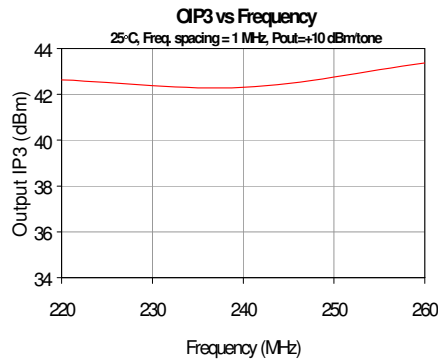
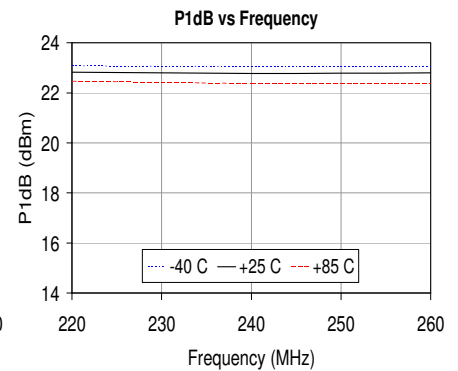
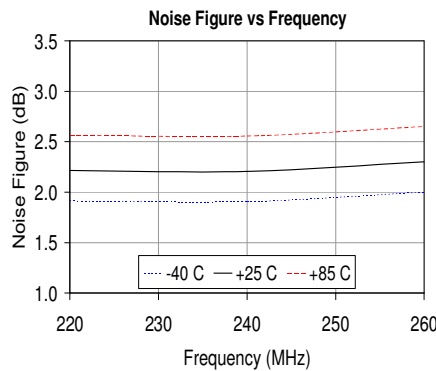
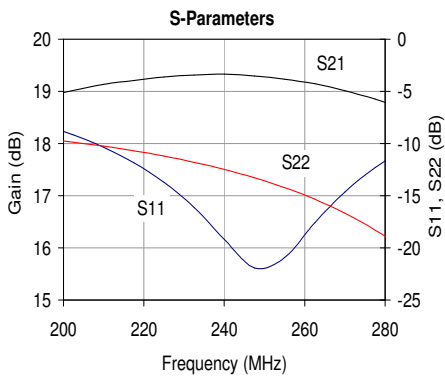



Application Circuit: 450 – 550 MHz (AH31-PCB500)

Typical Performance

| Frequency | 500 MHz |
|--------------|---------------|
| Gain | 18.4 dB |
| S11 | -12.7 dB |
| S22 | -9.2 dB |
| Output P1dB | +21 dBm |
| Output IP3 | +41 dBm |
| Noise Figure | 1.9 dB |
| Bias | +5 V @ 150 mA |

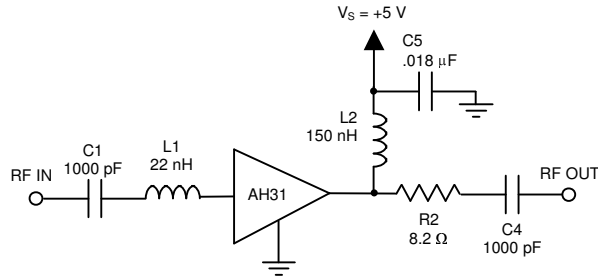

Notes:

1. The amplifier should be connected directly to a +5 V regulator; no dropping resistor is required.
2. If no DC signal is present at the input (pin 1), C1 can be removed. The gate is internally grounded in the amplifier.
3. R1, C2, and C3 (from the silkscreen) are not utilized in this application circuit.

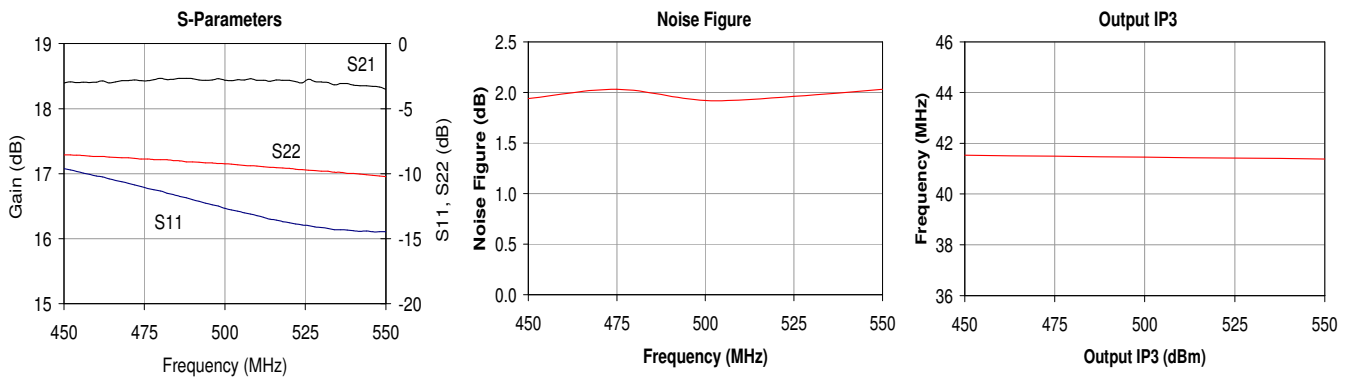

Reference Design: 900 MHz

Typical Performance

| Frequency | 900 MHz |
|--------------|--------------|
| S21 - Gain | 16.6 dB |
| S11 | -14 dB |
| S22 | -9 dB |
| Output P1dB | +20 dBm |
| Output IP3 | +41 dBm |
| Noise Figure | 2.2 dB |
| Bias | 5 V @ 150 mA |

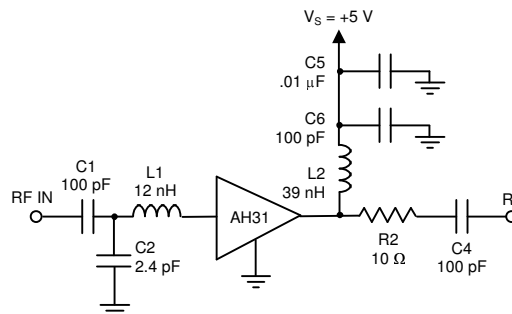

Notes:

1. The amplifier should be connected directly to a +5 V regulator; no dropping resistor is required.
2. If no DC signal is present at the input (pin 1), C1 can be removed. The gate is internally grounded in the amplifier.
3. R1 and C3 (from the silkscreen) are not utilized in this application circuit.

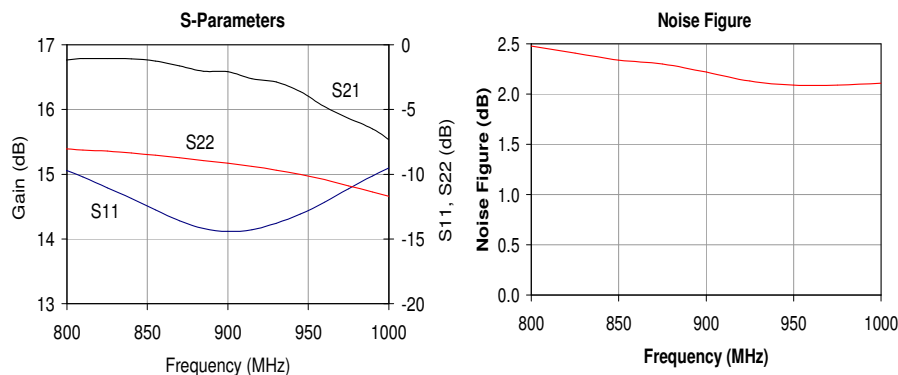

Specifications and information are subject to change without notice



Broader Bandwidth Reference Designs

The AH31 can be designed to achieve good performance over a broader frequency range (around one octave) by using an additional L-C matching network at the input. An equalization R-C network can also be added at the output to slightly flatten out the typical downward slope of the amplifier circuit.

Reference Design: 36 - 56 MHz

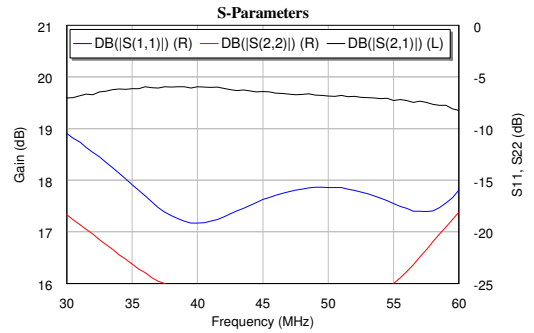
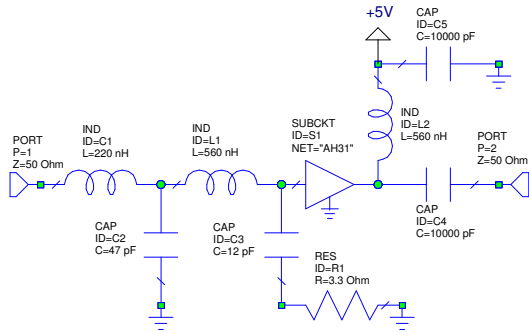

Reference Design: 45 - 90 MHz

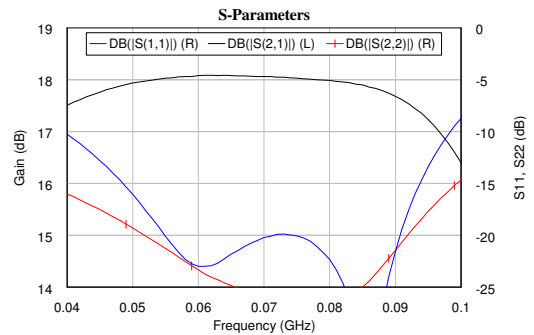
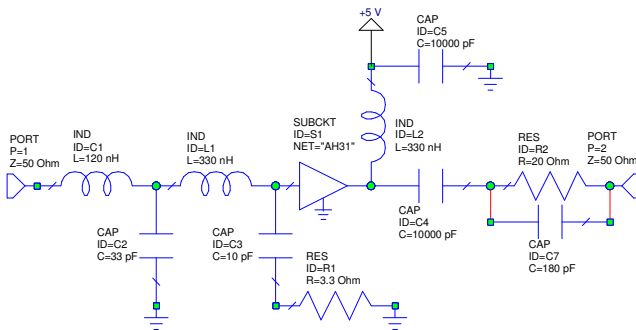

Reference Design: 65 - 165 MHz

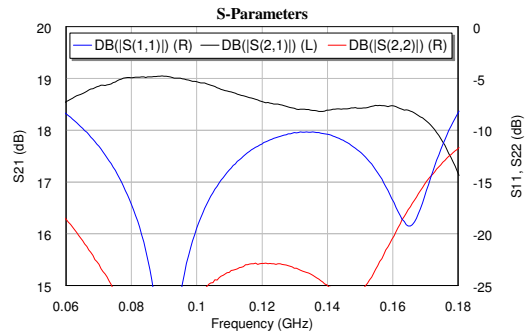
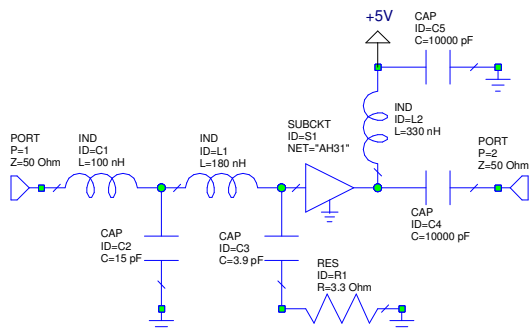

Reference Design: 80 - 200 MHz

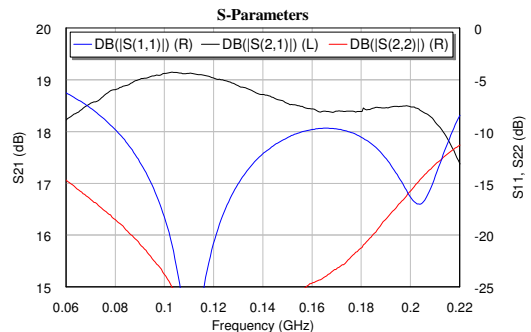
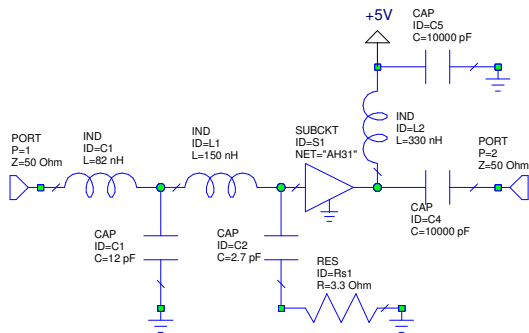

Specifications and information are subject to change without notice



AH31 (SOT-89 Package) Mechanical Information

This package may contain lead-bearing materials. The plating material on the leads is SnPb.

Outline Drawing

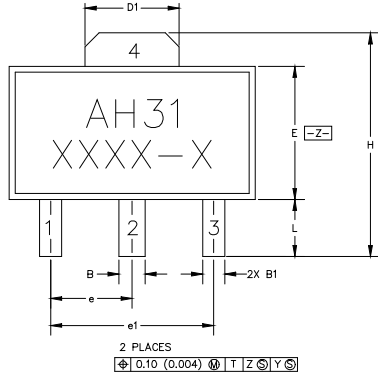

| SYMBOL | MIN | MAX |
|--------|--------------------|----------------|
| A | 1.40 (.055) | 1.60 (.063) |
| B | .44 (.017) | .56 (.022) |
| B1 | .36 (.014) | .48 (.019) |
| C | .35 (.014) | .44 (.017) |
| D | 4.40 (.173) | 4.60 (.181) |
| D1 | 1.62 (.064) | 1.83 (.072) |
| E | 2.29 (.090) | 2.60 (.102) |
| E1 | 2.01 (.079) | 2.29 (.090) |
| e | 1.50 BSC (.059) | |
| e1 | 3.00 BSC (.118) | |
| H | 3.94 (.155) | 4.25 (.167) |
| L | .89 (.035) | 1.20 (.047) |
| M | 4.04 (.159) | 4.19 (.165) |

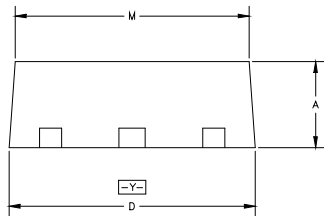

NOTES:

1. DIMENSIONS CONFORM WITH JEDEC TO-243C WHERE INDICATED.
2. DIMENSIONS ARE EXPRESSED IN MILLIMETERS.
3. DIMENSIONING AND TOLERANCING IN ACCORDANCE WITH ASME Y14.5.

Process Marking

The AH31 is marked with an "AH31" designator. An alphanumeric code ("XXXX-X") is also marked on the part designator on the top surface of the package.

For more information on this part see the application notes on the website in the "Application Notes" section.

MSL / ESD Rating

Warning! ESD sensitive device.

ESD Rating: Class 1B
 Value: Passes $\geq 500V$ to $<1000V$
 Human Body Model (HBM)
 Standard: JEDEC Standard JESD22-A114

ESD Rating: Class IV
 Value: Passes $\geq 1000V$ to $<2000V$
 Charged Device Model (CDM)
 Standard: JEDEC Standard JESD22-C101

MSL Rating: Level 3 at $+235^\circ C$ convection reflow
 Standard: JEDEC Standard J-STD-020

Land Pattern

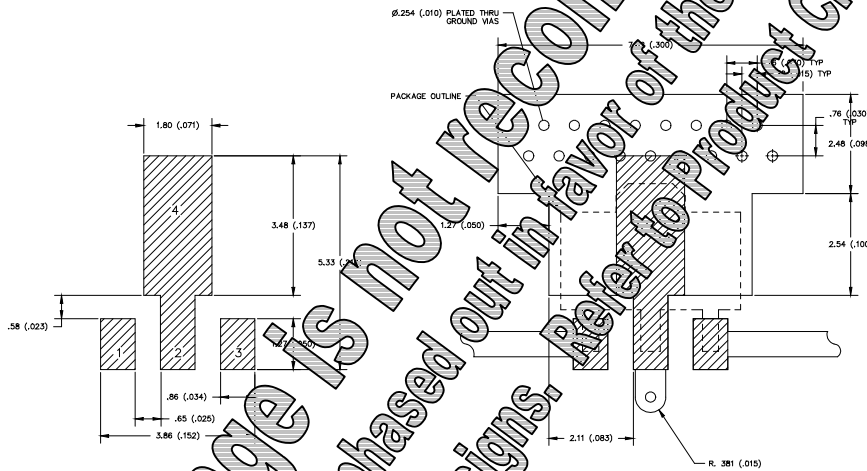

Mounting Config. Notes

1. Ground / thermal vias are critical for the performance of this device. Vias should use a .35mm (#80 / .0135") diameter drill and have a final plated thru diameter of .25 mm (.010").
2. Add as much copper as possible to inner and outer layers near the part to ensure optimal thermal performance.
3. Mounting screws can be added near the part to fasten the board to a heatsink. Ensure that the ground / thermal via region contacts the heatsink.
4. Do not put solder mask on the backside of the PC board in the region where the board contacts the heatsink.
5. RF trace width depends upon the PC board material and construction.
6. Use 1 oz. Copper minimum.
7. All dimensions are in millimeters (inches). Angles are in degrees.

Thermal Specifications

| Parameter | Value |
|------------------------------------|-------------------|
| Operating Temperature | $+85^\circ C$ |
| Thermal Resistance, θ_{j-c} | $1.5^\circ C / W$ |
| Junction Temperature, T_{jc} | $129^\circ C$ |

Thermal resistance is referenced from the hottest part of the junction to the ground tab (pin 4). This corresponds to the typical biasing condition of $+5V$, $100mA$ at $+25^\circ C$ case temperature. A minimum MTF of 1 million hours is achieved for junction temperatures below $160^\circ C$.

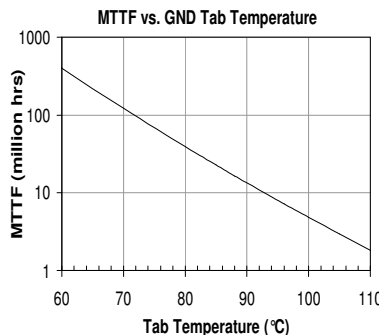



AH31

High Dynamic Range IF Amplifier

The Communications Edge™

Product Information

AH31-G (Green / Lead-free SOT-89 Package) Mechanical Information

This package is lead-free/Green/RoHS-compliant. It is compatible with both lead-free (maximum 260°C reflow temperature) and leaded (maximum 245°C reflow temperature) soldering processes. The plating material on the leads is NiPdAu.

Outline Drawing

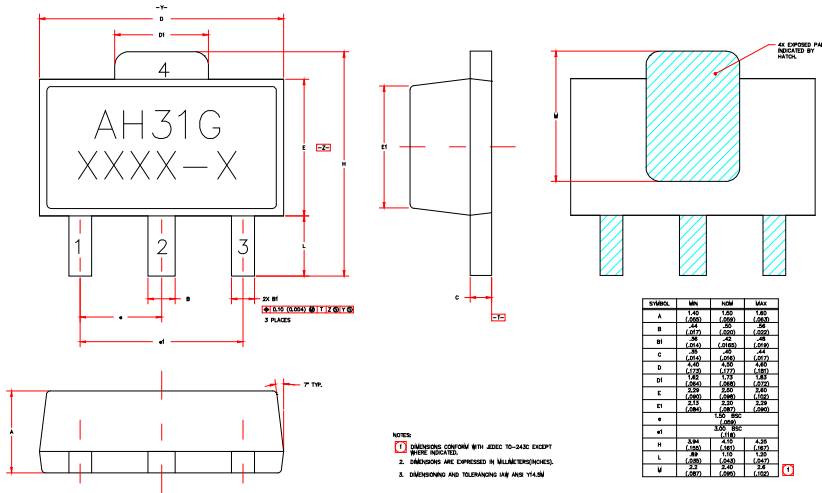

Product Marking

The AH31-G will be marked with an "AH31G" designator. An alphanumeric lot code ("XXXX-X") is also marked below the part designator on the top surface of the package.

Tape and reel specifications for this part are located on the website in the "Application Notes" section.

MSL / ESD Rating



Caution! ESD sensitive device.

ESD Rating: Class 1B
 Value: Passes $\geq 500V$ to $<1000V$
 Test: Human Body Model (HBM)
 Standard: JEDEC Standard JESD22-A114

ESD Rating: Class IV
 Value: Passes $\geq 1000V$ to $<2000V$
 Test: Charged Device Model (CDM)
 Standard: JEDEC Standard JESD22-C101

MSL Rating: Level 3 at $+260^\circ C$ convection reflow
 Standard: JEDEC Standard J-STD-020

Land Pattern

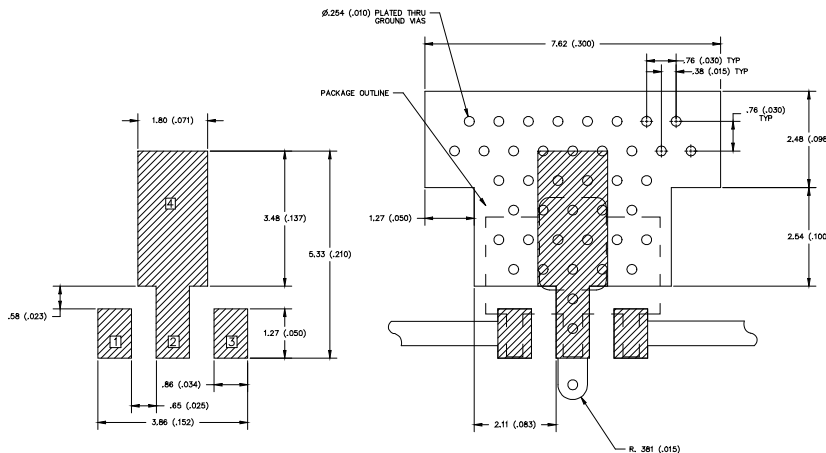

Thermal Specifications

| Parameter | Rating |
|--|--------------|
| Operating Case Temperature | -40 to +85°C |
| Thermal Resistance, Rth ⁽¹⁾ | 59° C / W |
| Junction Temperature, Tjc ⁽²⁾ | 129° C |

- The thermal resistance is referenced from the hottest part of the junction to the ground tab (pin 4).
- This corresponds to the typical biasing condition of +5V, 150 mA at an 85°C case temperature. A minimum MTTF of 1 million hours is achieved for junction temperatures below 160 °C.

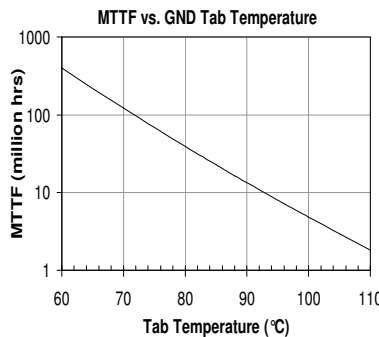

Mounting Config. Notes

- Ground / thermal vias are critical for the proper performance of this device. Vias should use a .35mm (#80 / .0135") diameter drill and have a final plated thru diameter of .25mm (.010").
- Add as much copper as possible to inner and outer layers near the part to ensure optimal thermal performance.
- Mounting screws can be added near the part to fasten the board to a heatsink. Ensure that the ground / thermal via region contacts the heatsink.
- Do not put solder mask on the backside of the PC board in the region where the board contacts the heatsink.
- RF trace width depends upon the PC board material and construction.
- Use 1 oz. Copper minimum.
- All dimensions are in millimeters (inches). Angles are in degrees.

Specifications and information are subject to change without notice